

UB2596001 PT-150 アメリカ

P  **USER'S GUIDE**
-TOUCH

 **Model PT-150**

brother

INTRODUCTION

Your new P-touch will help you design and print labels for any application. Extremely versatile, it can create characters of many sizes and styles. In addition, with the use of colorful tape cartridges, you can print labels with different letter colors.

You no longer have to worry about rushing tasks that require professional-type printing. The quality and performance of the P-touch make it a very versatile machine.

Although the P-touch is easy to use, we suggest that you read this manual carefully before starting. Please keep the manual in a handy place for future reference.

Good luck! We hope you enjoy using your P-touch.

FCC NOTICE

This equipment has been tested and found to comply with the limits for a Class B digital device, pursuant to Part 15 of the FCC Rules. These limits are designed to provide reasonable protection against harmful interference in a residential installation. This equipment generates, uses, and can radiate radio frequency energy and, if not installed and used in accordance with the instructions, may cause harmful interference to radio communications. However, there is no guarantee that interference will not occur in a particular installation. If this equipment does cause harmful interference to radio or television reception, which can be determined by turning the equipment off and on, the user is encouraged to try to correct the interference by one or more of the following measures:

- Reorient or relocate the receiving antenna
- Increase the separation between the equipment and receiver.
- Connect the equipment into an outlet on a circuit different from that to which the receiver is connected.
- Consult the dealer or an experienced radio/television technician for help.

Patent numbers and patent publication numbers which are related to this product are as below:

USP4922063
USP4927278
USP4966476
USP4983058
USP5009530

EP315369 (Pending)
EP322918 (Pending)
EP322919 (Pending)
GB2223740 (Pending)

CONTENTS

GENERAL OVERVIEW	2
GENERAL PRECAUTIONS	4
BEFORE YOU START	5
SELF DEMONSTRATION	5
LETTERING STICK	5
INSERTING A TAPE CASSETTE	6
INSERTING BATTERIES	7
CHANGING THE CUTTER UNIT	8
STARTING	9
CREATING A MESSAGE	10
DISPLAY	10
MOVING THE CURSOR	10
CLEARING THE MEMORY	11
KEY OPERATIONS	12
INPUT	13
SPACE KEY	13
SYMBOLS	15
EDITING A MESSAGE	18
DELETING	18
WORD OUT	19
OVERTYPING	20
INSERTING	21
PRINTING A LABEL	23
SIZE	24
STYLE	25
TAPE FEED	26
PRINTING & CUTTING	27
REPEAT PRINTING	28
HOW TO REMOVE LABEL BACKING	29
MESSAGE LIST	30
TROUBLESHOOTING	31
SPECIFICATIONS	32
ACCESSORIES	33
ACCESSORY ORDER FORM	37

GENERAL OVERVIEW

LCD display

To use functions written in green you must hold down the CODE key and press the desired function key.

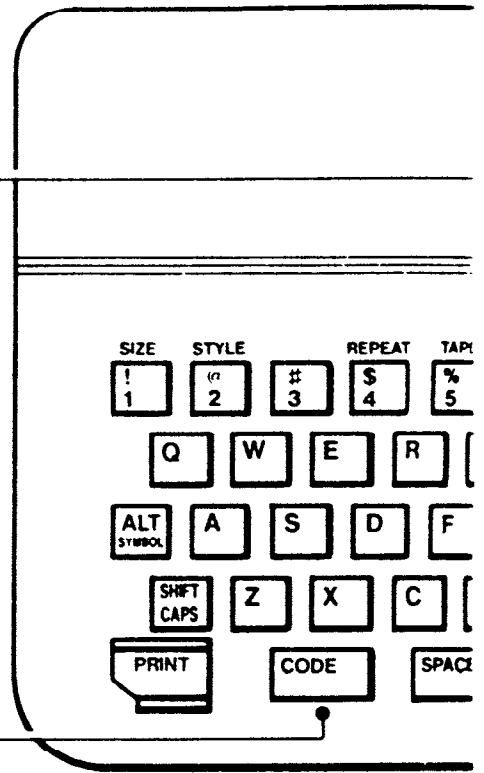

CODE key

Battery compartment latch

Battery compartment

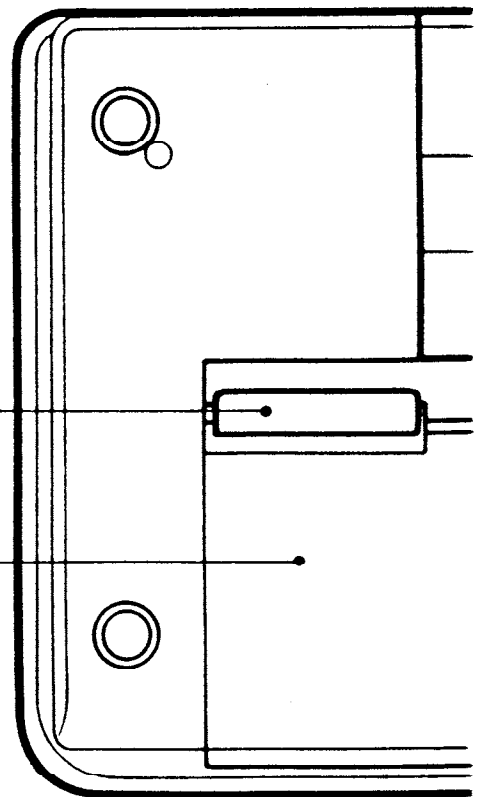

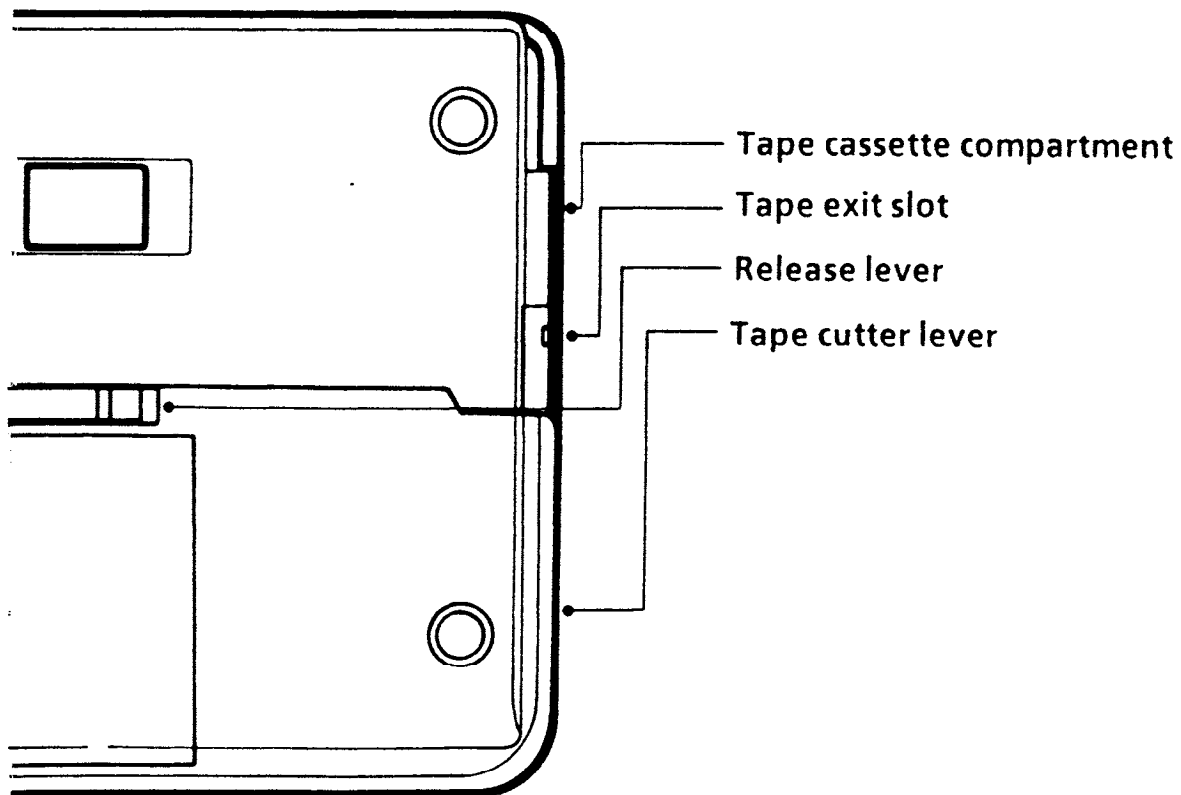
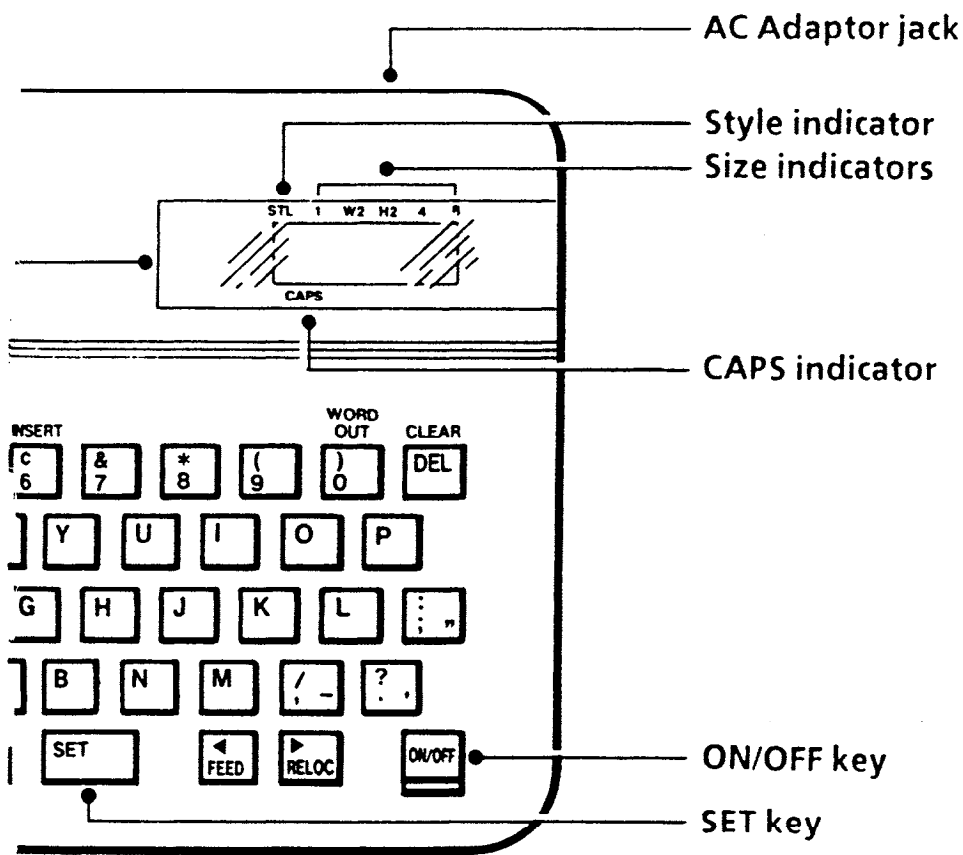

GENERAL PRECAUTIONS

- Do not pull the tape. This may damage the tape cassettes.
- Do not clean the machine with alcohol or other organic solvents. Use only a soft, dry cloth.
- Do not put anything onto or into the machine.
- Do not expose the machine to high temperatures or high humidity. Never leave it on the dashboard or in the trunk of your car.
- Do not use the machine in dusty places. Keep it out of both direct sunlight and rain.
- Remove the batteries and/or disconnect the AC Adaptor if you do not intend to use your machine for an extended period of time.
(Note: When power is disconnected, any messages in the working area be lost.)
- Do not leave any rubber or vinyl on the machine for an extended period of time. Doing so may cause staining.
- Use only the AC Adaptor, Model AD-20 designed exclusively for the P-touch.
- After inserting a new tape cassette, advance the tape by holding down the CODE key and pressing the FEED key once.
- Do not attach the adhesive label to your skin.
- Do not touch the print head mechanism. If the head is touched, clean it immediately with a soft wipe (e.g.cotton swab) to avoid permanent damage.

BEFORE YOU START



This unit has a built in self demonstration. Pressing the CODE + D keys will print the self demonstration. The label will print according to the current settings.



Lettering stick is enclosed with this package. This stick is convenient when you use instant lettering tape (see page 35). In addition to that, this stick helps you to remove label backing easily (see page 29).

**INSERTING A
TAPE
CASSETTE**

A tape cassette is supplied with this unit.

To insert a new tape cassette:

- (1) Turn the machine over. Remove the tape cassette compartment cover by pressing in the scored portion and lifting.
- (2) If there is an empty tape cassette in the compartment, pull up the release lever. Pull the used tape cassette straight up to remove it.
- (3) Remove the stopper from the new tape cassette. Use your finger to wind it in the direction of the arrow on the case two full times.
- (4) Insert the new tape cassette firmly into the compartment. Push down the release lever to lock the tape into place. Replace the compartment cover.
- (5) Advance the tape by holding down the CODE key and pressing the FEED key once.

Note: When inserting a tape cassette, make sure that the inner ribbon does not get caught on the corner of the metal securing stand.

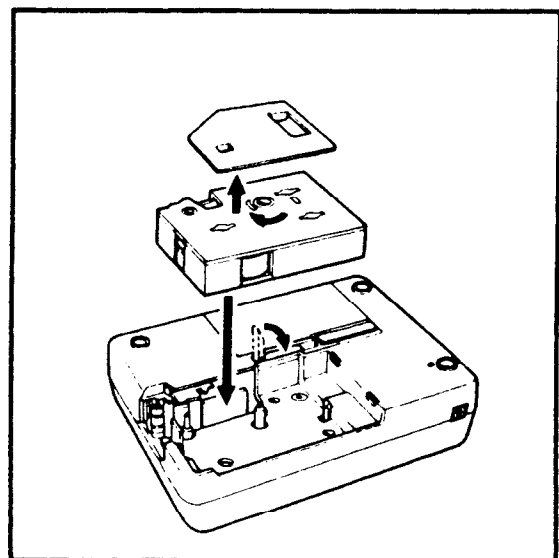
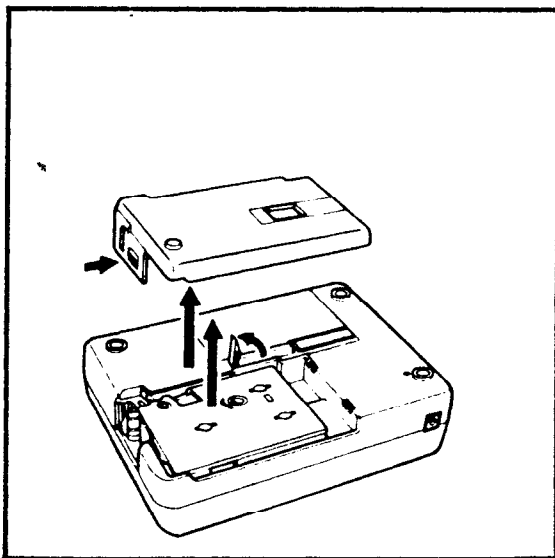

INSERTING BATTERIES

The machine uses five C-type batteries.

To insert batteries:

- (1) Turn the machine over. Remove the battery compartment cover by pinching the latch and lifting.
- (2) Follow the diagrams on the back of the compartment to insert the batteries in the proper direction.
- (3) After inserting the batteries, re-attach the battery compartment cover.

When "B.WEAK" (Batteries Weak) is displayed, replace the five batteries.

- Alkaline batteries are recommended.
- An optional AC Adaptor is available.

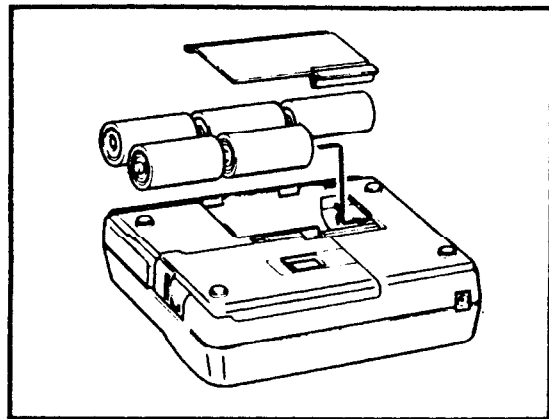
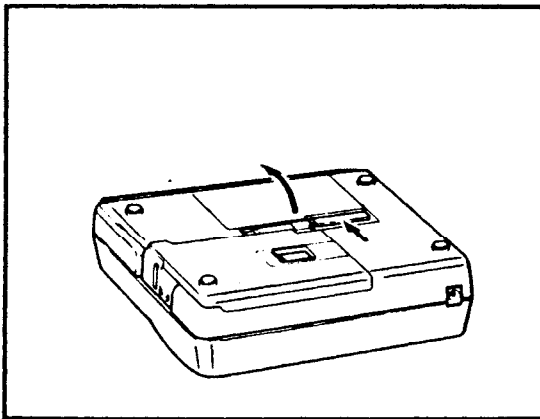

Note: When you remove or replace the batteries, any messages in the working area will be lost (unless an optional AC Adaptor is attached).

**CHANGING
THE CUTTER
UNIT**

Whenever the cutter does not cut well, replace it with a new blade.

Note: The expected life of the unit's cutter is approximately 3000 cuts.

To replace a dull or broken blade:

- (1) Turn the machine over. Open the tape cassette compartment cover. Pull up the tape cassette release lever. If a tape cassette is installed, carefully remove it. Push the empty side of the replacement unit down to grasp the old cutter.
- (2) Pull the replacement unit up to remove the cutter.
- (3) Turn the replacement unit over and line up the plastic teeth of the new cutter unit with the teeth on the machine's gear.
- (4) Push the replacement unit down to insert the new cutter into the machine.
- (5) Replace the compartment cover.

Refer to the Accessory Order Form on page 35 for purchasing new blades.

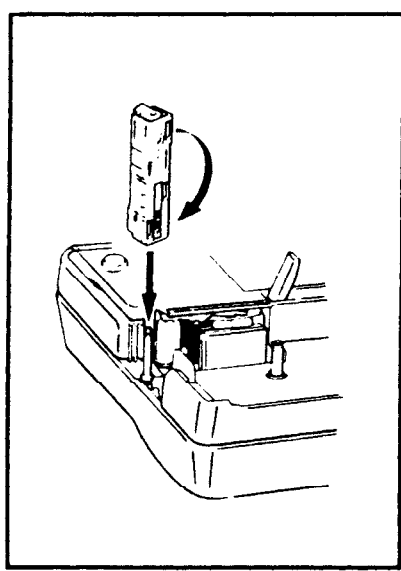
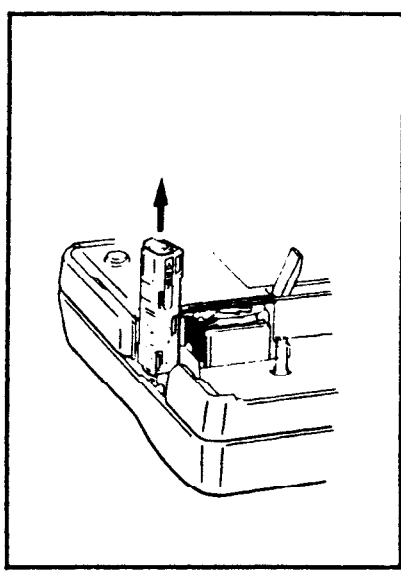
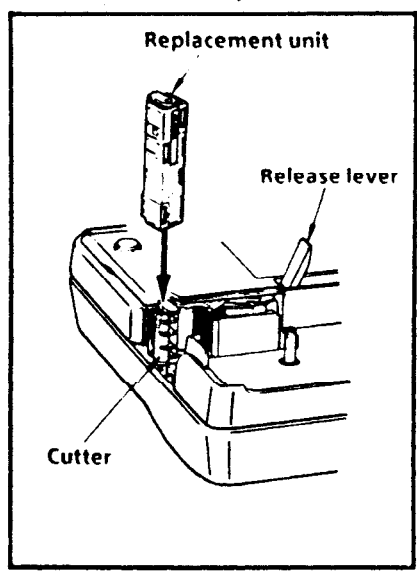

STARTING

To start the machine:

Press the ON/OFF key.

The machine's internal memory retains the last message created, and displays it when you turn on the machine. This feature allows you to stop work on a message, turn off the machine, and return to it later without having to re-enter the message.

The machine has an automatic turn-off feature. If the machine is on, but is not used for five minutes, it will automatically shut off. The message will be retained in memory until the machine is turned on again.

CREATING A MESSAGE

DISPLAY

You are now ready to create a message on the machine.

The machine's LCD display is six characters wide. You can create messages up to 45 characters in length. The six-character display is like a window which moves across your message.

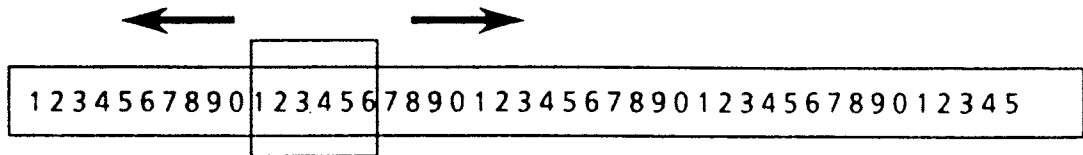

MOVING THE CURSOR

You can review and edit different parts of your message by moving the cursor backward and forward.

To move the cursor through your message:

Press the ◀ and ▶ keys to move the cursor one space at a time.

Hold down the CODE key and press the RELOCATE key to advance the cursor to the end of the message.

**CLEARING
THE
MEMORY**

Before entering a new message, you will often need to clear an old message.

To erase the previous message from the memory and the display:

Hold down the CODE key and press the CLEAR key.

In these boxes, we will work through a sample message, first creating it, then editing it, and finally printing it.

For the purpose of this example, suppose you are J. Smith, and you want to make a label with your name on it.

Example ● Erase any message from the memory by pressing

CODE + CLEAR
DEL

STL 1 W2 H2 4 8
△
CAPS

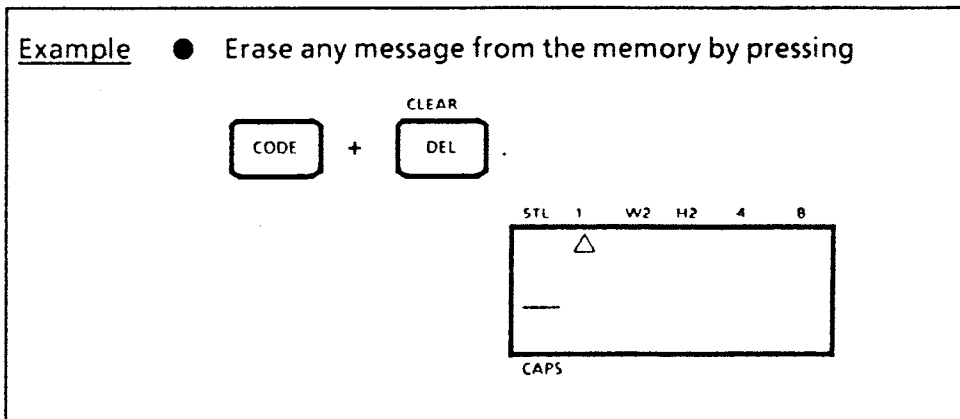

**KEY
OPERATIONS**

CODE KEY

By holding down the CODE key and pushing the appropriate key, you can use the functions written in green characters.

SHIFT/CAPS KEY

By using the SHIFT key you can type capital letters, and symbols located on the upper part of keys. To type a capital "A", hold the SHIFT key down and press the "A" key. To type a percent sign (located above the "5"), hold the SHIFT key down and press the "5" key.

By holding down the CODE key and pressing the CAPS key, you set the machine into CAPS mode. When this mode is entered, the CAPS indicator on the display turns on. In CAPS mode, capital letters can be typed simply by pressing the character keys. If number keys are pressed, numbers -- not the symbols above them result. For this reason, CAPS mode is particularly useful for creating messages containing many numerals and capital letters. To exit CAPS mode, press the CODE key and the CAPS key again.



ALT KEY

By holding down the ALT key and pressing the appropriate key, symbols located in the lower right-hand portion of the key top can be typed.



INPUT

You can now use the keys to enter a message.

Example To input "Mr.":

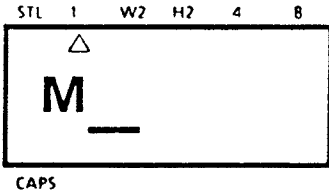
- Press  +  to input a capital M.



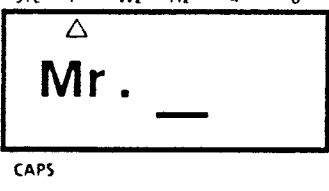

- Complete "Mr." by pressing  then .



SPACE KEY

Like that on a typewriter, the P-Touch's SPACE key lets you add a blank space into your message.

Note: The SPACE key and the  key have different functions. The  key moves the cursor forward without adding blank spaces.



Example

To complete the message "Mr. J Smith":

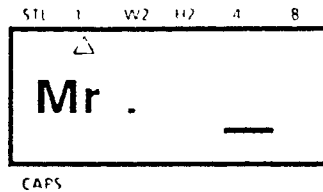
- Press  once to add a blank space.



Next enter the initial "J":

- Press  +  to input a capital J.
- Add a blank space by pressing  once.

Note: The "M" will move off of the display.

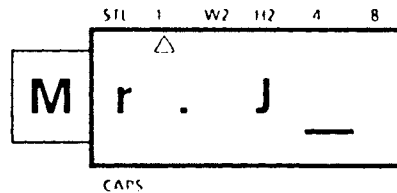

- Complete the message by entering "Smith".

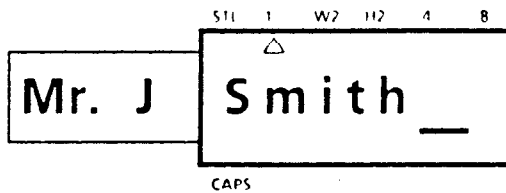

- If you make any mistakes during this input do not worry. Simply press  to remove the last character, and type again.

SYMBOLS

In addition to the 52 letters, 19 symbols, and 10 numerals on the key tops, there are 69 symbols available in Symbol Mode. These 69 additional symbols are arranged into twelve groups, corresponding to the letters A to L on the keyboard.

A	á	í	ó	é	ú	¶
B	Ü	ü	Ñ	ñ	Æ	æ
C	à	ò	ì	è	ù	÷
D	oz.	lb.	ft.	in.	°F	¥
E	Fr	2	3	4	5	6
F	7	8	9	↑	↓	→
G	←	↖	↘	↗	↙	★
H	●	•	○	□	◻	✎
I	♂	♀	{	}	<	>
J	[]	+	=	±	\
K	°	²	³	α	β	§
L	£	½	¼			



To input a symbol that is not on the key top:

- (1) Hold down the CODE key and press the SYMBOL key to enter Symbol Mode.
- (2) The display will read: "A-L key".

- (3) Press the key of the letter from A to L whose group contains the symbol you want. That letter's group of six symbols will be displayed.
- (4) Move the cursor to the symbol you want.
- (5) Press the SET key.

Example

To add a star (★) to the message, changing the message to "Mr. J Smith ★":

- Enter Symbol Mode by pressing  + .
- The following message will be displayed:

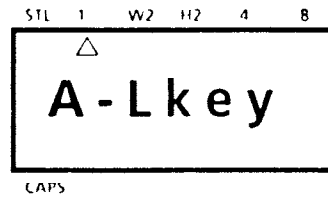

- Press the G key, as its group includes the ★ symbol. (Refer to the symbol chart on page 15.)

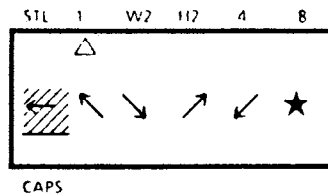

- Move the cursor to ★ by pressing 

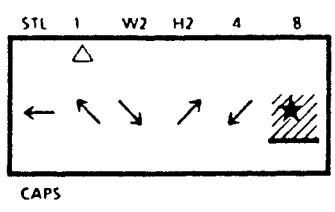

- Push  to input a ★.

The message should now look like this:

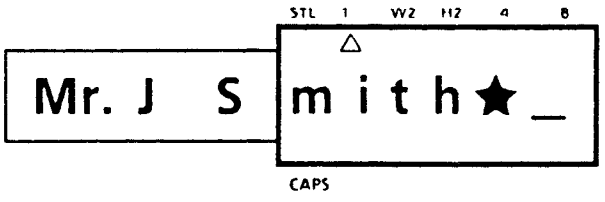

After a non-keyboard symbol has been entered, the machine automatically exits from Symbol Mode. If you wish to enter another symbol, you must re-enter Symbol Mode by holding down the CODE key and pressing the SYMBOL key.

EDITING A MESSAGE

DELETING

The DELETE key allows you to remove characters from your message.

To delete a character:

- (1) Using the ◀ and ▶ keys, position the cursor one space to the right of the character you want to delete.
- (2) Press the DELETE key.

After deletion, the cursor stays in the same position until all remaining characters to its left appear on the display.

If further deletions are made, the cursor and all characters following the deletion (including blank spaces) move one space to the left.

Example

To delete the ★ from the message:

- Make sure the cursor is positioned to the right of the ★.

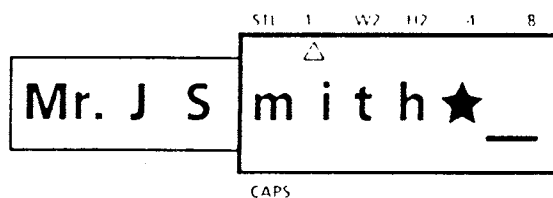

- Press  to remove the ★.

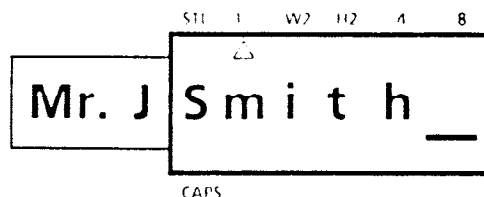

WORD OUT

This function allows you to erase one word at a time, simplifying the editing of long messages.

To use the Word Out function:

- (1) Position the cursor to the right of the word you want to delete.
- (2) Hold down the CODE key and press the WORD OUT key.



The blank space over the cursor and the preceding word will be deleted.

Example

To delete the word "Mr." from the message:

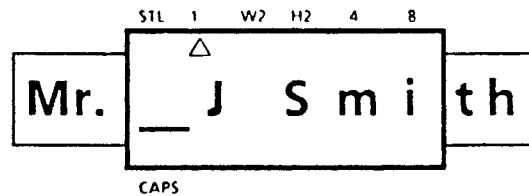
- Press  to position the cursor under the blank space to the right of "Mr.".



- Press  +  to delete "Mr.".

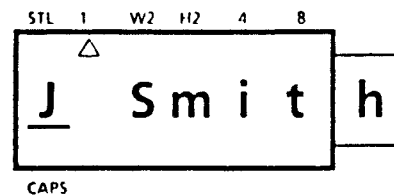

**OVER
TYPING**

The machine normally operates in Overtyping Mode. In Overtyping Mode, you can change a character simply by typing a new one in its place.

To type over a character:

- (1) Move the cursor to the character you want to change.
- (2) Press the character or symbol you want.

The new character replaces the old one in the message.

Example To replace the lower-case letters "mith" with capital letters:

- Position the cursor under the "m"

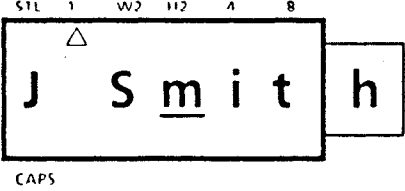

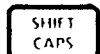
- Switch to CAPS Mode by pressing  + . The CAPS indicator will light.
- Press the M key.

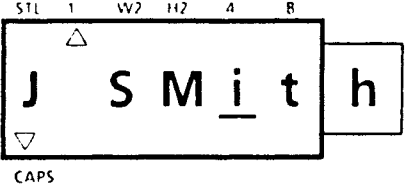

- Complete the process by typing the letters "ITH".

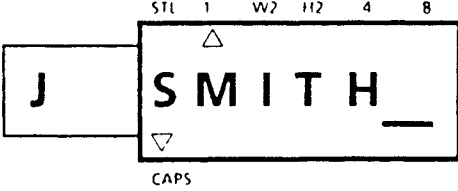

INSERTING

Sometimes you may want to insert a character into the middle of your message. To do so, you must change from Over-type Mode to Insert Mode.

To insert characters:

- (1) Move the cursor to the position where you want to insert.
- (2) Hold down the CODE key and press the INSERT key to enter Insert Mode.
- (3) Press the keyboard character or symbol you want to add, or choose an auxiliary symbol in Symbol Mode (see SYMBOLS).

All characters following the insertion will move one space to the right.

Example

To insert a period into the message, changing it to "J. SMITH":

- Position the cursor under the blank space between the "J" and the "S".

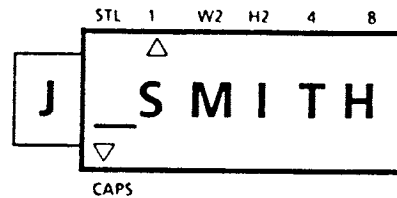

- Enter Insert Mode by pressing



- Press the period key.

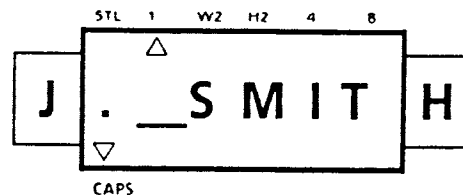

You can leave Insert Mode by advancing the cursor to the end of the message. When you leave Insert Mode, you automatically return to Overtyping Mode.

To leave Insert Mode:

Move the cursor to the end of the message by holding down the CODE key and pressing the RELOCATE key.

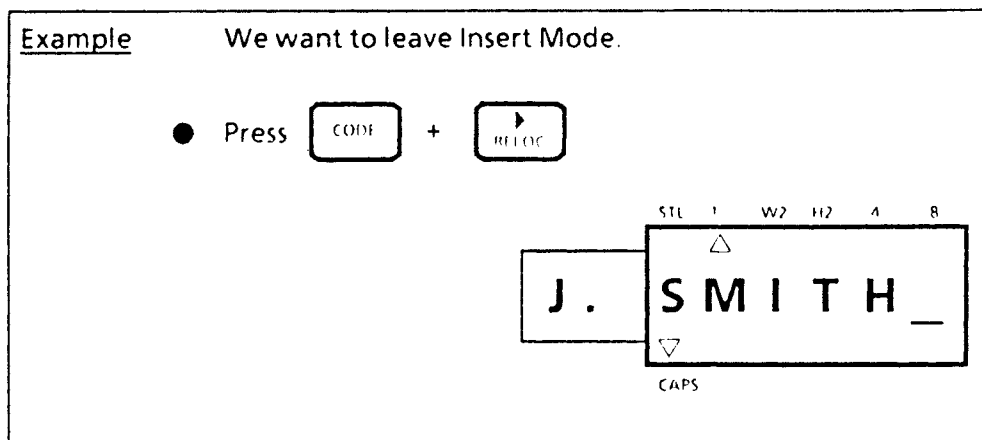

PRINTING A LABEL

You can print your completed message using a variety of different character sizes and styles.

Choose character size and style, before printing the label.

Note: The type of character you choose will be used for all the characters in your message. It is not possible to have two different character sizes or styles within one message.

Various print styles available on the P-Touch :

Standard Size Normal

J. SMITH

Double Width Normal

J. SMITH

Double Height Normal

J. SMITH

Double Width & Double Height Normal

J. SMITH

Standard Size Vertical

J
.
S
M
I
T
H

4XWidth & Double Height Normal

J. SMITH

4XWidth & Double Height Outline

J. SMITH

4XWidth & Double Height Bold

J. SMITH

4XWidth & Double Height Shadow

J. SMITH

SIZE

There are five different character sizes you can select for your label:

1	- Standard Size	H2	- Double Height
W2	- Double Width		
4	- Double Width & Double Height		
8	- 4 x Width & Double Height		

To choose a character size:

(1) Holding down the CODE key, press the SIZE key to change the character size and advance the size indicator on the display in the following order:

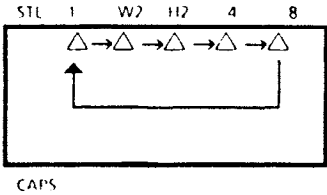



(2) Stop pressing the SIZE key when your desired character size is indicated.

Example To use Double Width and Double Height (4) characters:

- Hold down and press until the size indicator is aligned with the 4.

STYLE

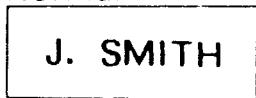
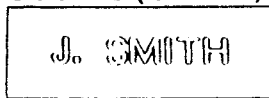
There are also five different print styles:

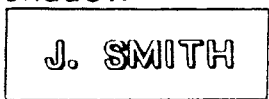
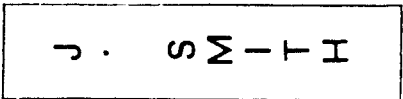
- | | |
|--|---|
| 1 - Normal | 2 - Outline (O.LINE) |
|  |  |
| 3 - Bold | 4 - Shadow |
|  |  |
| 5 - Vertical (VERTCL) | |
|  | |

To choose a print style for your label:



- (1) Holding down the CODE key, press the STYLE key once. The display will show the current print style.
- (2) Still holding down the CODE key, press the STYLE key again. The available print styles will appear in order.
- (3) When the style you want is displayed, release the CODE key.

If you select a style other than Normal, the style indicator will be visible on the display.

Note: Only Normal style characters can be printed vertically.

Example

To use Outline print:

- Hold down 
- Press  until the display reads "O.LINE"

The style indicator turns on.

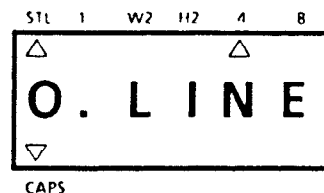

- Release 

TAPE FEED

The machine normally advances the tape after printing. Sometimes, however, you may want to add characters to the end of the message you have printed. To do so, you must change the Auto Tape Feed Mode from "ON" to "OFF" before printing.

To change the Tape Feed Mode:

- (1) Press the CODE key and the TAPE key.
- (2) The current feed mode appears on the display.
- (3) Still holding down the CODE key, press the TAPE key again. The display changes between the following two messages:

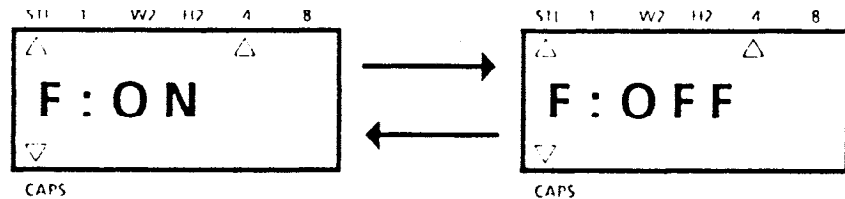

- (4) When the mode you want (Feed "ON" or "OFF") is displayed, release the CODE key.

Note: If you want to print a label that contains more than 45 characters, you may want to turn the feed off. Then you can print the label in stages, without interruptions.

To manually feed the tape, hold down the CODE key and press the FEED key.

Example To use Automatic Tape Feed:

- Hold down **CODE** and press **TAPE** until the display reads "F-ON"
- Release **CODE**

**PRINTING &
CUTTING**

After you have chosen the character size, print style, and tape feed style, you are ready to print the label.

To print a label:

Press the PRINT key.

The printed label comes out of the tape exit slot on the side of the machine.

Example To print the message onto a label:

- Press 

A label reading "J. SMITH" written in Double Width & Double Height Outline characters will be printed.

To cut the tape:

Pull out the tape cutter lever on the side of the machine.

Note: Do not pull on the tape. This may damage the tape cassette.

If you pull out the tape cutter lever too far, it may break. Be careful not to pull it past the line on the lever.

Do not attempt to cut the tape during printing or feeding.

Example To cut the label:

- Pull out the tape cutter lever.

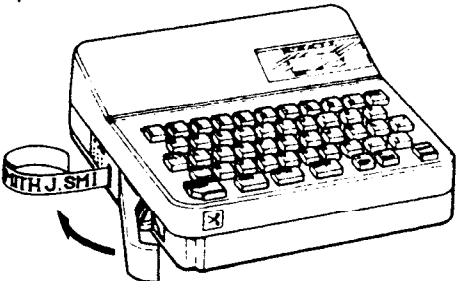

**REPEAT
PRINTING**

The Repeat function allows you to repeatedly print the same label up to ten times.

To use the Repeat Printing function:

(1) Hold down the CODE key and press the REPEAT key.

(2) The following message appears on the display:

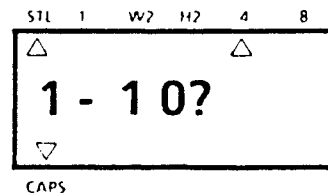

(3) Select the number of labels you want. For example, if you want ten labels to be printed, type 10.

(4) Press print.

Notes: A maximum of ten copies can be printed.
Cutting is not done automatically.
Never try to cut the tape during printing.
There is 4-mm space between repeated messages, even if Auto Tape Feed Mode is not set.
Press the ON/OFF key immediately if the tape runs out before all printing is finished.

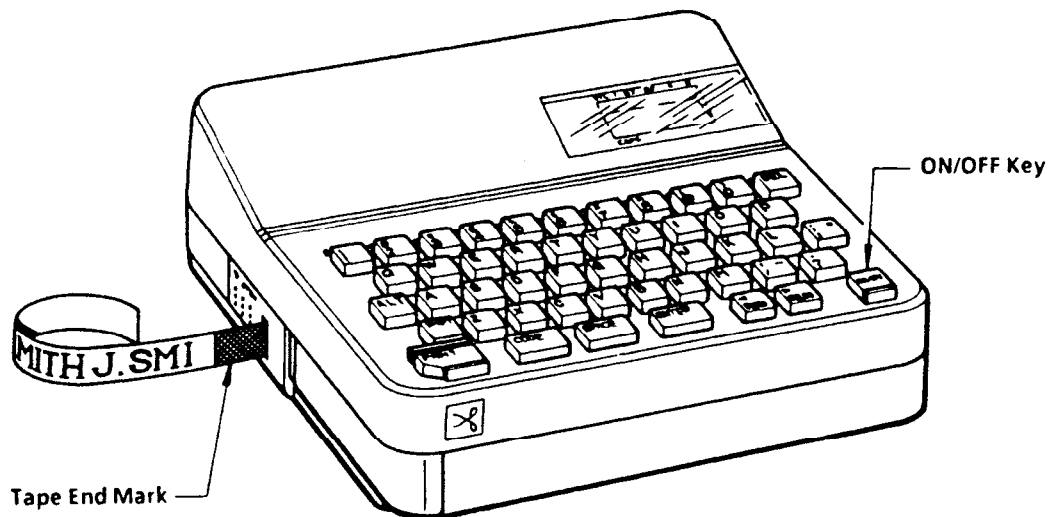

**HOW TO
REMOVE
LABEL
BACKING**

The enclosed stick enables the label backing of the tape to be removed easily.

- (1) Hold the tape in the left hand with printed surface up, and hold the stick in the right hand.
- (2) Pass the tape halfway through the long narrow hole of the stick.
- (3) After turning the stick inward halfway, pull the stick to the right.

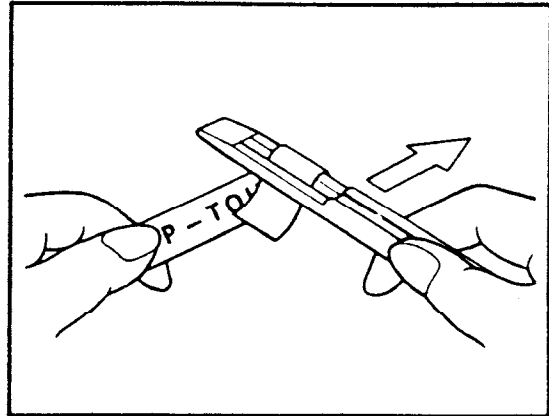
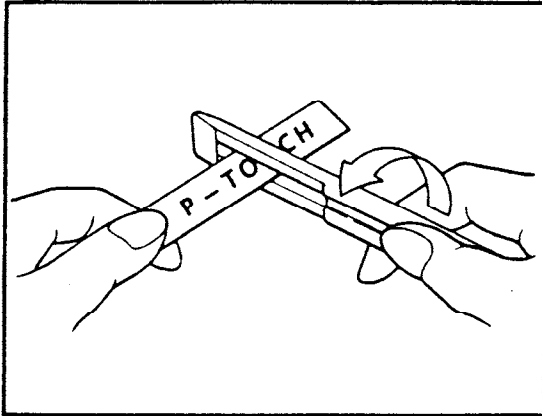

MESSAGE LIST

ERROR	Input error.
B.WEAK	The batteries are weak.
M.FULL	The working area is full (max:45 characters).
A - L key	See page 15.
NORMAL	See page 25.
O. LINE	
BOLD	
SHADOW	
VERTCL	
F : ON	See page 26.
F : OFF	
1 - 10?	See page 28.

TROUBLESHOOTING

Problem	What to Do
1. The display stays blank after you have turned on the machine.	<ul style="list-style-type: none">● Check the polarity of the batteries.● If the batteries are low, replace them.
2. The machine does not print, or the printed characters are blurred.	<ul style="list-style-type: none">● Check that the tape cassette has been inserted properly.● If the tape cassette is empty, replace it with a new one.● Make sure that the release lever has been closed properly.
3. The printed characters are not formed properly.	<ul style="list-style-type: none">● The batteries are probably weak. Replace them.
4. The tape cannot be cut.	<ul style="list-style-type: none">● The cutting blade is probably dull. Replace the blade.
5. Silver tape appears.	<ul style="list-style-type: none">● You have reached the end of the tape. Replace it with a new tape.
6. The memory has cleared on its own.	<ul style="list-style-type: none">● The batteries are probably weak. Replace them.

SPECIFICATIONS

Input Device:	49 keys (39 character keys and 10 function keys)
Print Speed:	12 cps (standard size)
Character Size:	Standard Size (1) Double Width (W2) Double Height (H2) Double Width & Double Height (4) 4 x Width & Double Height (8)
Internal Character: Generator:	Standard Character Font Enlarged Character Font Font: LORI PS (150 characters)
Print Tape:	Pressure-sensitive adhesive-based $\frac{1}{2}$ " (W): 300" (L)
LCD:	7 x 5 dots 1 line x 6 columns 1/8 duty
Power Supply:	Batteries (C-type x 5) or optional AC Adaptor The power automatically turns off when no key is pushed for five minutes.
Dimensions:	6.69" (W) x 5.04" (D) x 2.20" (H)
Weight:	1.1 lb (without batteries)
Memory Buffer Size:	45 characters

ACCESSORIES

- **Supplies**

Obtain tape cassettes, AC Adaptors tape cutters and carry case from your nearest authorized dealer. Brother cannot be held responsible for trouble caused by the use of unauthorized supplies.

- **Tapes**

Each tape cassette is 25 feet long.

Stock No.	Description	QTY/ Package	Price
12mm (1/2") Tapes			
TC-10	Black Characters on Clear Adhesive	2	34.95
TC-11	Red Characters on Clear Adhesive	2	34.95
TC-12	Blue Characters on Clear Adhesive	2	34.95
TC-13	Gold Characters on Clear Adhesive	2	39.95
TC-20	Black Characters on White Adhesive	2	34.95
TC-21	Red Characters on White Adhesive	2	34.95
TC-22	Blue Characters on White Adhesive	2	34.95
TC-30	Red Characters on Clear Adhesive Blue Characters on Clear Adhesive Gold Characters on Clear Adhesive	3 (1 EACH)	49.95

Stock No.	Description	QTY/ Package	Price
TC-5001	Black Characters on Red Adhesive	1	17.95
TC-6001	Black Characters on Blue Adhesive	1	17.95
TC-7001	Black Characters on Yellow Adhesive	1	17.95
TC-8001	Black Characters on Green Adhesive	1	17.95
TC-33	Gold Characters on Black Adhesive	2	39.95
TC-40	Red Characters on White Adhesive Blue Characters on White Adhesive Gold Characters on Black Adhesive	3 (1 EACH)	49.95
9-mm Tapes (3/8")			
TC-34Z	White Characters on Black Adhesive	2	34.95
TC-14Z1	White Characters on Clear Adhesive	1	19.95
TC-20Z1	Black Characters on White Adhesive	1	17.95
TC-54Z1	White Characters on Red Adhesive	1	19.95
TC-64Z1	White Characters on Blue Adhesive	1	19.95
TC-74Z1	White Characters on Orange Adhesive	1	19.95
TC-84Z1	White Characters on Green Adhesive	1	19.95
TC-90Z1	Black Characters on Gold Adhesive	1	19.95
TC-A0Z1	Black Characters on Silver Adhesive	1	19.95
MAT Tapes (9mm) (3/8") (Recommended for use when photocopying; helps eliminate shadow lines.)			
TC-M0Z	Black Characters on Semi-Clear Adhesive	2	39.95

Stock No.	Description	QTY/ Package	Price
<p>Instant Lettering Tape (Rub-on characters)</p> <p>Instant lettering tapes act as rub-on character transfers. After creating a message, simply position the characters over a sheet of paper. By rubbing the instant lettering tape's non-printed side with the enclosed lettering stick, you can transfer the tape's contents directly onto the paper.</p> <p>Caution: Hold tape very tight and do not move while rubbing the tape.</p> <div data-bbox="997 583 1284 806" style="text-align: center;"> </div>			
TC-00	Black Characters	2	34.95
TC-01	Red Characters	2	34.95
TC-02	Blue Characters	2	34.95
Others			
AD-20	AC Adaptor	1	19.95
TC-8	Replacement Tape Cutter	1	9.95
6990	Carry Case	1	29.95

UB2596001